

# THD (GNSS METHOD)/GNSS COMPASS

## NGC-3000

- Highly accurate heading of 0.4° RMS
- Full GNSS with GPS, BDS, GLONASS, GALILEO
- Both THD (transmitting heading device) and GNSS
- Large LCD, 7 inch/color, touch screen operation
- Highly accurate SOG, COG, ROT and position
- Multi outputs of RS422 & LAN
- Data interface to BAM System/INS
- Up to five display modes available
- Compliant with IMO MSC.116 (73) for THD
- Maintenance-free design
- Type approval with CCS



ANTENNA UNIT



PROCESSOR UNIT



DISPLAY UNIT

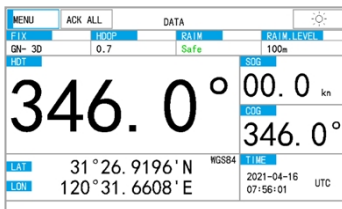

DATA (NAV DATA)

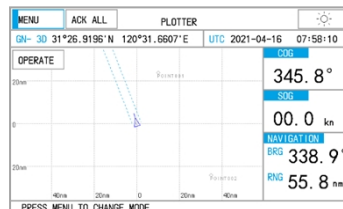

PLOTTER

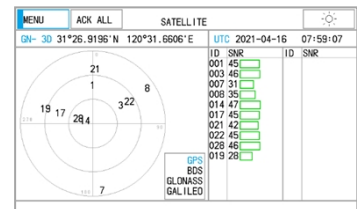

SATELLITE

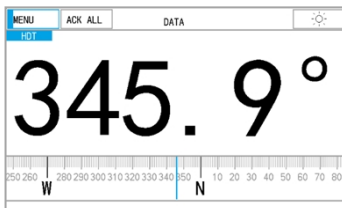

DATA (HEADING)

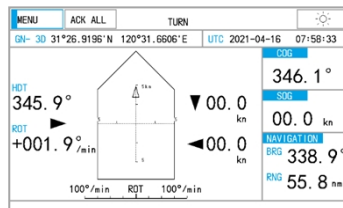

TURN

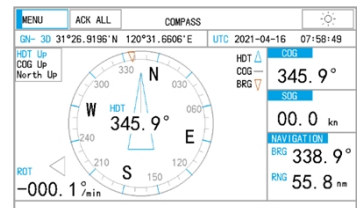

COMPASS



## SPECIFICATIONS

### ● GENERAL

- Heading accuracy: 0.4° RMS
- Heading resolution: 0.1°
- Tracking rate of turn: 45/sec
- Tracking acceleration: 1G
- Pitch/roll angle: ±60°
- Receiving frequencies: GPS L1/L2, BDS B1/B2, GLONASS L1/L2, GALILEO E1/E5b
- Position accuracy: 1.5 m
- Speed accuracy: 0.03 m/s
- Position fixing time: <30 s
- Data output rate: max 20 Hz

### ● DISPLAY

- Display system: 7 inch, color LCD, touch screen operation, 154 (W)×87 (H) mm
- Resolution: 800×480 dots
- Display mode: DATA (Heading, NAV data), PLOTTER, TURN, COMPASS, SATELLITE

### ● INTERFACE

- Output ports: 3 IEC-61162-1 Ed4, Ed5, NMEA 1.5, 2.0, 2.3  
1 IEC-61162-450 LAN, RJ45 connector
- Transmission speed: 4800/9600/19200/38400 bps (selectable)
- BAM/INS in/out: ACN, ALC, ALF, HBT
- Data sentences: HDT, THS, ROT, RMC, GGA, VTG, ZDA, DTM, GLL, GST, ALC, ALF, HBT, RTE, WPL (selectable)

- **POWER SUPPLY:** DC 24 V 500 mA (range DC 12~36 V)

### ● ENVIRONMENTAL CONDITION

- Temperature range: -20°C~+55°C operating  
-30°C~+70°C storage (Antenna)
- IP grade: IP22 (Processor unit & Display Unit)  
IP66 (Antenna Unit)
- Compass safe distance: 1.15m (Standard)

- **DIMENSION:** 174 (W)×81 (H)×200 (D) mm (Processor Unit)  
264 (W)×145 (H)×83 (D) mm (Display Unit)  
810 (W)×107 (H)×160 (D) mm (Antenna Unit)

## EQUIPMENT LIST

### ● STANDARD

- |                  |           |       |
|------------------|-----------|-------|
| - Processor Unit | NGC-3000P | 1 pc  |
| - Display Unit   | NGC-3000D | 1 pc  |
| - Antenna        | NGA300    | 2 pc  |
| - Accessories    |           | 1 set |

### ● OPTIONS

- |  |  |      |
|--|--|------|
| - Flush Mount Bracket for Display Unit |  | 1 pc |
|--|--|------|

## SIZE DIMENSION

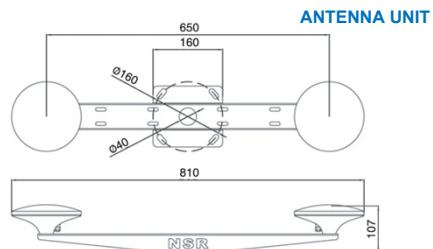
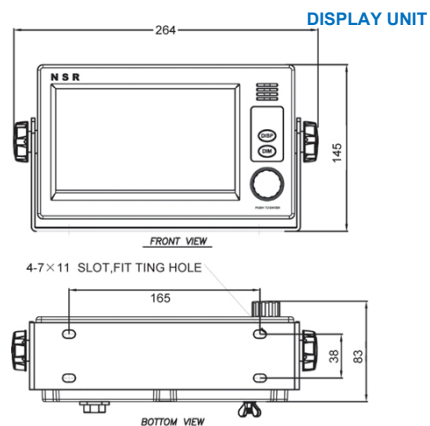
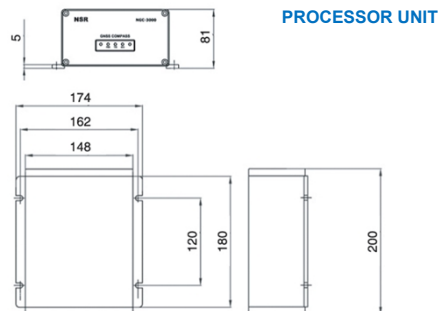

## SYSTEM DIAGRAM

